

HARRINGTON METAL FACE STORZ SPECIFICATION SHEET

HFDC30-5040NPT/Cap

Aluminum Connections:

Hard Anodized to Mil-A-8625f, Type 3, Dark Gray

- 30° Elbow (356), 4" NPT female x 5" BSP male
Zinc Rich Primer & Powder Coated
- 5" **METAL FACE STORZ** x 5" BSP Female
with 5" BSP Gasket
- 5" Storz Cap attached with cable
with 5" Storz Pressure Seal

- Stainless Steel Reflective Aircraft Cable

- 250 psi working pressure

MADE IN USA, Elbow Made In Canada

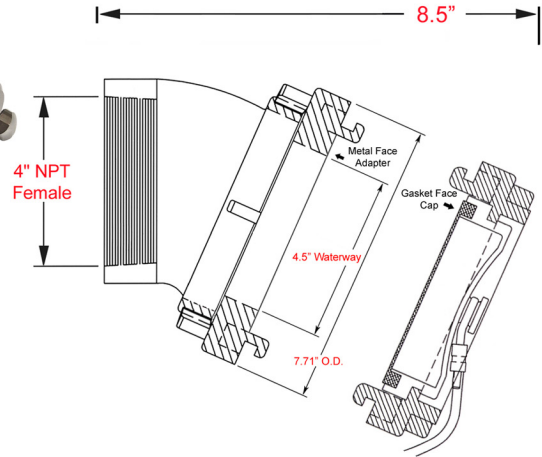

Harrington

STORZ CONNECT

2630 West 21st Street
Erie, PA 16506

ph. 800-553-0078
info@harrinc.com



HFDC30-5040NPT/Cap

Elbow 30°, 4" NPT Female x 5" Metal Face Storz
with Storz Cap/stainless steel reflective aircraft cable

Date: 01/01/24

Weight: 9 lbs.

Specification / Data Sheet

Not to scale



NFPA 1963 COMPLIANT

30° NPT