

HARRINGTON STORZ SPECIFICATION SHEET

HSMR50-60NPT/Cap

All Aluminum

- **6" NPT MALE**
- **5" STORZ** with Storz-Lok
- **5" STORZ CAP**
attached with SS Aircraft Cable

- **Hard Anodized 6061-T6 Aluminum Storz & NPT**
- **250 psi working pressure**

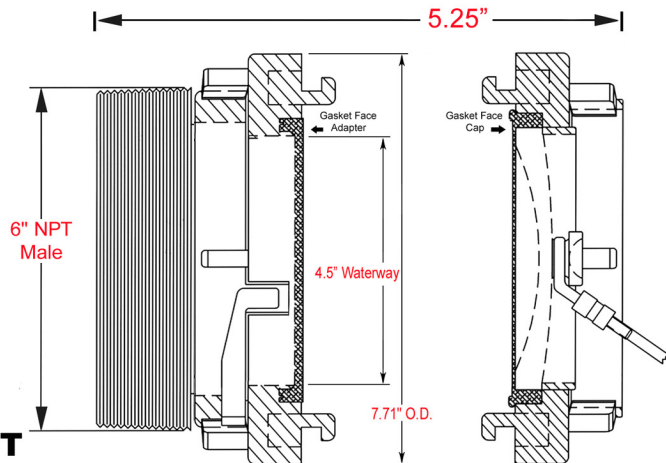

Specify **HARRINGTON STORZ: HSMR50-60NPT/Cap**



Harrington
STORZ CONNECT

2630 West 21st Street
Erie, PA 16506

ph. 800-553-0078
info@harrinc.com



HSMR50-60NPT/Cap

6" NPT Male x 5" Storz with Storz Cap attached
with stainless steel aircraft cable

Date: 01/01/23

Weight: 9 lbs.

Specification / Data Sheet

Not to scale



NFPA 1963 COMPLIANT

NPT